

Modelling of n -Stage Blumlein Stacked Lines for Bipolar Pulse Generation

J.P.M. Mendes^{1,4}, Luis M. Redondo^{1,2}, H. Canacsinh¹, M. Vieira^{1,4},
and José O. Rossi³

¹ Instituto Superior de Engenharia de Lisboa, ISEL, Lisboa, Portugal

² Centro de Física Nuclear, Universidade de Lisboa, CFNUL, Lisboa, Portugal

³ Laboratório Associado de Plasma, Instituto Nacional de Pesquisas Espaciais, INPE,
São Paulo, Brasil

⁴ Faculdade de Ciências e Tecnologia, Universidade Nova de Lisboa, FCT-UNL,
Lisboa, Portugal

Abstract. A Blumlein line is a particular Pulse Forming Line, PFL, configuration that allows the generation of high-voltage sub-microsecond square pulses, with the same voltage amplitude as the dc charging voltage, into a matching load. By stacking n Blumlein lines one can multiply in theory by n the input dc voltage charging amplitude. In order to understand the operating behavior of this electromagnetic system and to further optimize its operation it is fundamental to theoretically model it, that is to calculate the voltage amplitudes at each circuit point and the time instant that happens. In order to do this, one needs to define the reflection and transmission coefficients where impedance discontinuity occurs. The experimental results of a fast solid-state switch, which discharges a three stage Blumlein stack, will be compared with theoretical ones.

Keywords: Blumlein line, propagation waves, reflection coefficient, transmission coefficient, voltage gain.

1 Introduction and Contribution to Value Creation

Short duration high voltage pulses with fast rise and fall times and flat top are required for many applications such as: medical treatment, food and water sterilization and exhaust gas discharge [1-3]. A practical way of getting high voltage, almost, rectangular pulses, with width less than one microsecond, are with the help of PFL. A quick rise time switch is necessary for achieving these pulses and the most used ones in the literature for high voltage amplitudes are spark gaps [4]. However, the evolution of solid-state switches in terms of voltage amplitude, rise time, internal resistance, price and size make this technology an alternative for switching stack transmission lines [5], making this systems more compact and less expensive.

The basic operation principle of single transmission line and up to two stack Blumlein line generator have been characterized in many articles and books, such as,

[3, 4, 6-9], for unipolar generator. In [10], appear the hybrid modulator capable of delivering a high voltage bipolar pulse, Blumlein generator.

In order to understand the completely voltage wave propagation phenomena in each stage, this work derives an n^{th} model for the reflection and transmission coefficients of a Blumlein stack intended for bipolar generation, considering a matched load. The correct theoretical modeling allows the assembling of high-voltage pulse modulators with better pulse shape characteristics, which in terms results in enhanced performance in applications areas such as medical treatment where this is critical. Theoretical time evolution of the voltage in load will be compared with experimental ones for a three stage Blumlein stacked generator.

It is expected that this technology after being completely developed may avoid the time consuming, expensive cost and painful traditional treatments, improving significantly the quality of life of deceased people.

2 Calculation of the Reflection and Transmission Coefficients in a Blumlein Line System

Each Blumlein line cell is composed of two identical transmission lines with characteristic impedance Z_0 , and length l , connected in series. Stacking stages in parallel allows a Blumlein generator to multiply the voltage source amplitude by the number of stages, as seen in Fig. 1 for a Blumlein stack for one up to three stages.

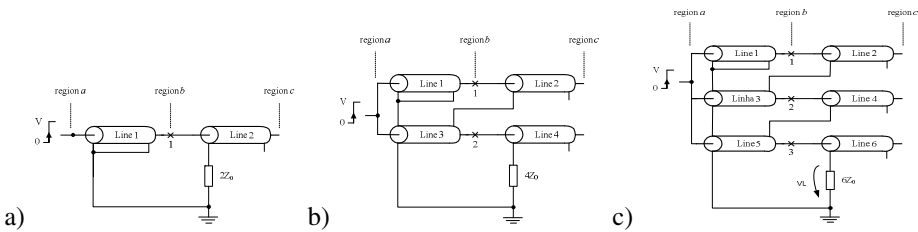

Fig. 1. Blumlein system with a) one; b) two and c) three stages

The voltage waves injected in each line propagate in a medium characterized by impedance, $Z = \sqrt{\frac{\mu}{\epsilon}}$, with transition time t_0 , along one section of line, $t_0 = \frac{l}{v_p}$, with

propagation velocity v_p , $v_p = \frac{c}{\sqrt{\epsilon_r}}$, where ϵ , μ , μ_r and c , are respectively the

permittivity, permeability, relative permeability of the dielectric insulation used and the speed of light. The reflection ρ and transmission τ coefficients are calculated from:

$$\rho = \frac{Z_r - Z_i}{Z_r + Z_i} \tag{1}$$

$$\tau = 1 + \rho \tag{2}$$

where Z_r and Z_i are, respectively, the impedance to the back and front, in relation to ground, of the considered line point.

2.1 Blumlein Stack

One Blumlein stage comprises two identical transmission lines connected in series, as shown in Fig. 1 a). There are three characteristic impedance regions where discontinuity occurs: a , b and c . In each there are reflected and transmitted voltage waves. Considering a voltage V injected in Line 1, and the internal resistance of the source null, as in a short-circuit, then in region a the reflection coefficient ρ_a and transmission coefficient τ_a are, respectively, $\rho_a = -1$ and $\tau_a = 0$. For region b , the reflection coefficient ρ_b , is:

$$\rho_b = \frac{(Z_0 + 2Z_0) - Z_0}{(Z_0 + 2Z_0) + Z_0} = \frac{2Z_0}{4Z_0} = \frac{1}{2}. \tag{3}$$

For region c , the open circuit end of the line, the reflection coefficient ρ_c and transmission coefficient τ_c are, respectively, $\rho_c = 1$ and $\tau_c = 2$.

Two Blumlein stages comprise four identical transmission lines connected, as in Fig. 1 b), where regions a and c are the as in Fig. 1 a). Then for region b , the reflection coefficient ρ_b are, respectively, for the two stages,

$$\rho_{b1} = \frac{(Z_0 + Z_0 + Z_0 + 4Z_0) - Z_0}{(Z_0 + Z_0 + Z_0 + 4Z_0) + Z_0} = \frac{6Z_0}{8Z_0} = \frac{3}{4} \tag{4}$$

$$\rho_{b2} = \frac{(Z_0 + 4Z_0) - (Z_0 + Z_0 + Z_0)}{(Z_0 + 4Z_0) + (Z_0 + Z_0 + Z_0)} = \frac{2Z_0}{8Z_0} = \frac{1}{4} \tag{5}$$

Three Blumlein stages comprise six identical transmission lines connected, as in Fig. 1 c), where regions a and c are the as in Fig. 1 a). Then for region b , the reflection coefficient ρ_b are, respectively, for the three stages,

$$\rho_{b1} = \frac{(Z_0 + Z_0 + Z_0 + Z_0 + Z_0 + 6Z_0) - Z_0}{(Z_0 + Z_0 + Z_0 + Z_0 + Z_0 + 6Z_0) + Z_0} = \frac{10Z_0}{12Z_0} = \frac{5}{6} \tag{6}$$

$$\rho_{b2} = \frac{(Z_0 + Z_0 + Z_0 + 6Z_0) - (Z_0 + Z_0 + Z_0)}{(Z_0 + Z_0 + Z_0 + 6Z_0) + (Z_0 + Z_0 + Z_0)} = \frac{6Z_0}{12Z_0} = \frac{3}{6} \tag{7}$$

$$\rho_{b3} = \frac{(Z_0 + 6Z_0) - (Z_0 + Z_0 + Z_0 + Z_0 + Z_0)}{(Z_0 + 6Z_0) + (Z_0 + Z_0 + Z_0 + Z_0 + Z_0)} = \frac{2Z_0}{12Z_0} = \frac{1}{6} \tag{8}$$

The n stages Blumlein system is composed by $2n$ identical transmission lines connected in agreement with Fig. 2 circuit.

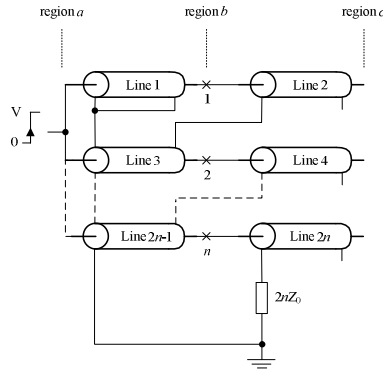

Fig. 2. Blumlein system with n stages

3 Influence of Other Stages

In order to account for the influence of the voltage waves in each stage, one must explicit the reflection and transmission coefficients calculated in the last section with the contribution for the reflected and transmitted voltage in each stage.

In regions a and c there aren't any influence of other stages because region a , it was considered that the voltage source internal resistance is null, and in region c , each transmission line is independent of each other, thus this study is center in region b . Hence, considering a two Blumlein stack, as in Fig. 1 b), a reflected voltage wave in the first stage takes into account that,

$$\rho_1 = \rho_{b1} - \rho_{b2} = \frac{3}{4} - \frac{1}{4} = \frac{2}{4} = \frac{1}{2}. \tag{9}$$

A reflected wave in the second stage takes into account that,

$$\rho_2 = \rho_{b2} + \frac{\tau_{b1}}{7} = \frac{1}{4} + \frac{\frac{7}{4}}{7} = \frac{2}{4} = \frac{1}{2}. \tag{10}$$

In addition, a transmitted wave in the first stage takes into account that,

$$\tau_1 = \frac{\tau_{b1}}{7} - (-\rho_{b2}) = \frac{\frac{7}{4}}{7} - \left(-\frac{1}{4}\right) = \frac{2}{4} = \frac{1}{2}. \tag{11}$$

A transmitted wave in the second stage takes into account that,

$$\tau_2 = \frac{\tau_{b2}}{5} + \frac{\tau_{b1}}{7} = \frac{\frac{5}{4}}{5} + \frac{\frac{7}{4}}{7} = \frac{2}{4} = \frac{1}{2}. \tag{12}$$

Considering a three Blumlein stack, as in Fig. 1 c), a reflected voltage wave in the first stage takes into account that,

$$\rho_1 = \rho_{b1} - (\rho_{b2} - \rho_{b3}) = \frac{5}{6} - \left(\frac{3}{6} - \frac{1}{6}\right) = \frac{3}{6} = \frac{1}{2}. \tag{13}$$

A reflected wave in the second stage takes into account that,

$$\rho_2 = \rho_{b2} + \frac{\tau_{b1}}{11} - \rho_{b3} = \frac{3}{6} + \frac{\frac{11}{6}}{11} - \frac{1}{6} = \frac{3}{6} = \frac{1}{2}. \tag{14}$$

And the reflected wave in the third stage takes into account that,

$$\rho_3 = \rho_{b3} + \frac{\tau_{b1}}{11} + \frac{\tau_{b2}}{9} = \frac{1}{6} + \frac{\frac{11}{6}}{11} + \frac{\frac{9}{6}}{9} = \frac{3}{6} = \frac{1}{2}. \tag{15}$$

In addition, a transmitted wave in the first stage takes into account that,

$$\tau_1 = \frac{\tau_{b1}}{11} - (-\rho_{b2} + \rho_{b3}) = \frac{\frac{11}{6}}{11} - \left(-\frac{3}{6} + \frac{1}{6}\right) = \frac{3}{6} = \frac{1}{2}. \tag{16}$$

A transmitted wave in the second stage takes into account that,

$$\tau_2 = \frac{\tau_{b2}}{9} + \frac{\tau_{b1}}{11} - (-\rho_{b3}) = \frac{\frac{9}{6}}{9} + \frac{\frac{11}{6}}{11} - \left(-\frac{1}{6}\right) = \frac{3}{6} = \frac{1}{2}. \tag{17}$$

And a transmitted wave in the third stage takes into account that

$$\tau_3 = \frac{\tau_{b3}}{7} + \frac{\tau_{b1}}{11} + \frac{\tau_{b2}}{9} = \frac{\frac{7}{6}}{7} + \frac{\frac{11}{6}}{11} + \frac{\frac{9}{6}}{9} = \frac{3}{6} = \frac{1}{2}. \tag{18}$$

Consequently, for n stages the reflected waves take into account that,

$$\left\{ \begin{aligned} \rho_x^n &= \sum_1^{x-1} \frac{\tau_{bx}}{4n - 2x + 1} + \sum_x^n (-1)^{x-1} \rho_{bx} = \frac{1}{2} \text{ if } x \text{ is odd} \\ \rho_x^n &= \sum_1^{x-1} \frac{\tau_{b(x-1)}}{4n - 2(x-1) + 1} + \sum_x^n (-1)^x \rho_{bx} = \frac{1}{2} \text{ if } x \text{ is even} \end{aligned} \right. \quad \forall x, n \in N. \tag{19}$$

Also, for n stages the transmitted waves take into account that,

$$\left\{ \begin{aligned} \tau_x^n &= \sum_1^x \frac{\tau_{bx}}{4n - 2x + 1} - \left(\sum_{x+1}^n (-1)^{x+1} \rho_{bx}\right) = \frac{1}{2} \text{ if } x \text{ is odd} \\ \tau_x^n &= \sum_1^x \frac{\tau_{bx}}{4n - 2x + 1} + \sum_{x+1}^n (-1)^{x+1} \rho_{b(x+1)} = \frac{1}{2} \text{ if } x \text{ is even} \end{aligned} \right. \quad \forall x, n \in N \tag{20}$$

4 Theoretical Results versus Experimental Results

Considering a three stage Blumlein system, the theoretical results, presented in Fig. 3.1 thru Fig. 6, show the time diagram of the voltage propagation waves in each line, for simplicity it was assumed the odd transmission lines as active line and the even transmission lines as passive line, in agreement with Fig. 1 c), as in [11], for the coefficients determined in the last section.

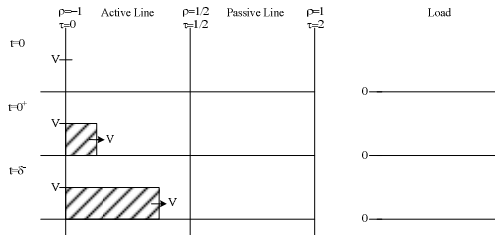

Fig. 3. Propagation voltage waves and load voltage between $0 < t < \delta$

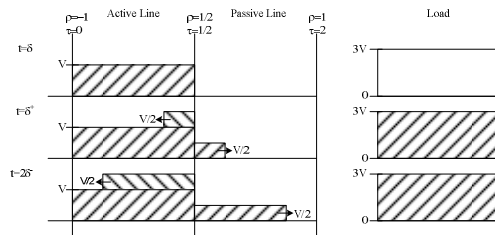

Fig. 4. Propagation voltage waves and load voltage between $\delta < t < 2\delta$

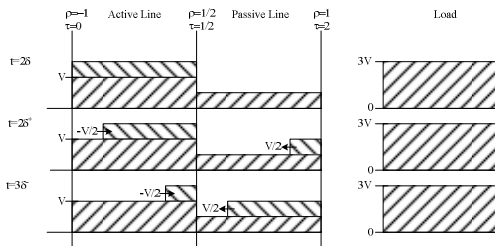

Fig. 5. Propagation voltage waves and load voltage between $2\delta < t < 3\delta$

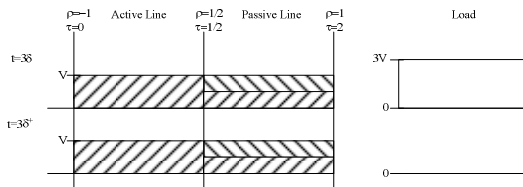

Fig. 6. Propagation voltage waves and load voltage between $3\delta < t < 3\delta$

For validate the theoretical model, a experimental Blumlein generator prototype with three stages (Fig. 1 c)) was assembled, using URM43 coaxial cable, characteristic impedance of 50Ω , with 5 m of length per line, speed of propagation 66% of the light speed, and transition time 25 ns in each transmission line. A fast MOSFET DE475-102N21A, with rise and fall times below 10 ns, was used to charge and discharge the stack.

In agreement of Fig. 1.c), Fig. 7 and Fig. 8 show the results of the positive and negative output pulse V_L , after charging the system with $V=1$ kV amplitude during a long time ($> 150 \mu\text{s}$) and afterward discharged in a matched load.

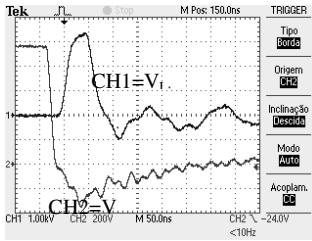

Fig. 7. Experimental positive pulse, V_L , 1kV/div and input charging voltage V , 200V/div, both width 50 ns/div

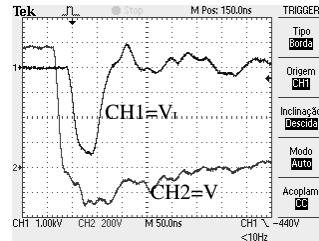

Fig. 8. Experimental negative pulse, V_L , 1kV/div and input charging voltage V , 200V/div, both width 50 ns/div

Comparing the results of the theoretical model with the experimental ones, it is observed that an approximately 50 ns bipolar pulse is generated with 3 kV. However, the model doesn't consider the experimental losses and devices nonlinearities.

5 Conclusions

A mathematical model of Blumlein stack generator was derived, considering the reflection and transmission coefficients, for an n^{th} stages system. The experimental results of a three stages 1 kV prototype were compared with the theoretical for the 3 kV bipolar output voltage produced into a matched load. Good agreement was reach, however because the real system parameters and losses it will be interesting in the future to try to model also the real line characteristics.

Acknowledgments. This work was supported by the Portuguese National Strategic Reference Framework, QREN, under project 1600/A2P2/2008.

References

- [1] Mir, L., Orlowski, S., Teissié Jr., J.B., Rols, M., Sersa, G., Miklavcic, D., Gilbert, R., Heller, R.: Biomedical applications of electric pulses with special emphasis on antitumor electrochemotherapy. *Bioelectrochemistry and Bioenergetics* 38, 203–207 (1995)

- [2] Barsotti, L., Cheftel, J.: Food processing by pulsed electric fields. II. Biological aspects. *Food Reviews International* 15, 181–213 (1999)
- [3] Raso, J., Heinz, V.: *Pulse Electric Fields Technology for the Food Industry*. Springer, United States of America (2006)
- [4] Gupta, D., John, P.: Design and construction of double-Blumlein HV pulse power supply. *Sādhanā* 26, 475–484 (2001)
- [5] Jiang, W., Wang, X., Yuan, J., Liu, K., Qiu, J., Yokoo, T., Takayama, K., Wake, M., Shimizu, N., Tokuchi, A.: Compact pulsed power and its industrial applications. Presented at the IEEE International Pulsed Power Conference, pp. 1–10 (2009)
- [6] Somerville, I., MacGregor, S., Farish, O.: An efficient stacked-Blumlein HV pulse generator. *Meas. Sci. Technol.* 1, 865–868 (1990)
- [7] Riveletto, M., Pignolet, P.: Characterization and realization of a 120 kV, 200 ns transmission line pulse generator. *The European Physical Journal Applied Physics* 3, 159–167 (1998)
- [8] Smith, P.: *Transient electronics and pulsed power circuit technology*. John Wiley & Sons, New York (2002)
- [9] Verma, R., Shyam, A., Shah, K.: Design and performance analysis of transmission line-based nanosecond pulse multiplier. *Sādhanā* 31, 597–611 (2006)
- [10] Mendes, J.P.M., Canacsinh, H., Redondo, L.M., Rossi, J.O.: Solid State Marx Modulator with Blumlein Stack for Bipolar Pulse Generation. *IEEE Transactions on Dielectrics and Electrical Insulation* 18, 1199–1204 (2011)
- [11] Rossi, J., Ueda, M., Barroso, J.: Design and Construction of a 150kV/300A/1 μ s Blumlein Pulser. *WSEAS Transactions on Systems* 2, 24–28 (2003)